

Line

120-125-127

AIRCOMP

Comandi a pannello con corpo in tecnopolimero
Panel mounting actuators with technopolymer body

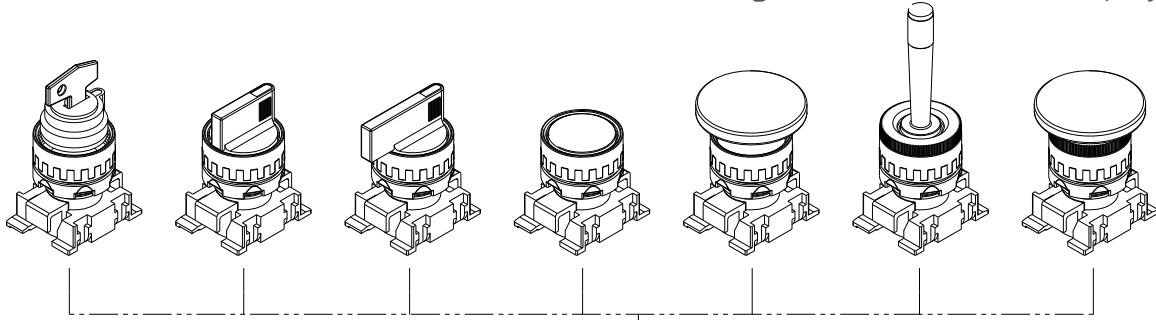

Misure di foratura
Drilling measures

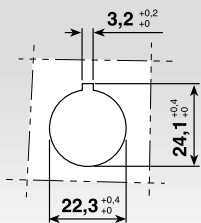

LINE 100

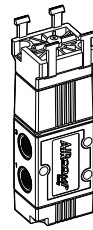

LINE 120
LINE 127

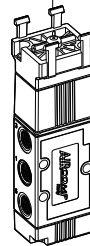

LINE 120
LINE 125
LINE 127

NB: I codici e le caratteristiche delle linee 120, 125 e 127, per comandi manuali a pannello, sono consultabili alle pagine 138; 143; 154; 170; 175.

NB: For codes and features of lines 120, 125 and 127, with manual panel mounting actuator, refer to pages 138; 143; 154; 170; 175.

Selettore a chiave 2 posizioni. Corpo in tecnopolimero, elemento frontale rotondo.
2 Positions key selector. Technopolymer body, round front element.



POSITION	CODE	REF.
	1003A00031	SELETTORE RT201N

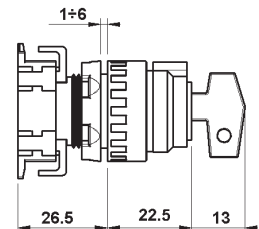

Selettore a leva corta 2 - 3 posizioni. Corpo in tecnopolimero, elemento frontale rotondo.
2 - 3 Positions short lever selector. Technopolymer body, round front element.



POSITION	CODE	REF.
	1003A00032	SELETTORE RT300N
	1003A00033	SELETTORE RT350N
	1003A00034	SELETTORE RT313N
	1003A00035	SELETTORE RT383N

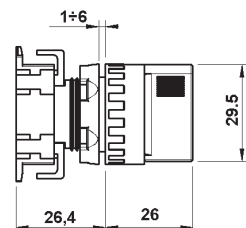



Selettore a leva lunga 2 - 3 posizioni.
Corpo in tecnopolimero, elemento frontale rotondo.
2 - 3 Positions long lever selector.
Technopolymer body, round front element.



POSITION	CODE	REF.
	1003A00036	SELETTORE RT400N
	1003A00037	SELETTORE RT450N
	1003A00038	SELETTORE RT413N
	1003A00039	SELETTORE RT483N

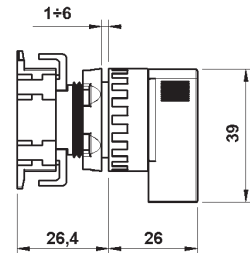

Pulsante protetto. Corpo in tecnopolimero, elemento frontale rotondo.
Protected push button. Technopolymer body, round front element.



COLOR	CODE	REF.
-	1003A00040	PULSANTE RT010 ^(*)
bianco-white	1003A00047	PIASTRINA BIANCA - WHITE COVER
nero-black	1003A00048	PIASTRINA NERA - BLACK COVER
rosso-red	1003A00049	PIASTRINA ROSSA - RED COVER
blu-blue	1003A00019	PIASTRINA BLU - BLUE COVER
giallo-yellow	1003A00020	PIASTRINA GIALLA - YELLOW COVER
verde-green	1003A00021	PIASTRINA VERDE - GREEN COVER

^(*)Fornito senza piastrina
^(*)Provided without cover

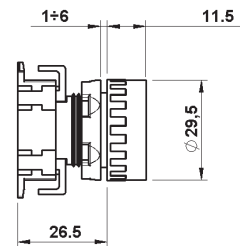

Fungo assiale ad impulso. Corpo in tecnopolimeri frontale rotondo.
Axial mushroom. Technopolymer body, round front element.



COLOR	CODE	REF.
rosso-red	1003A00041	FUNGO RT050R
nero-black	1003A00042	FUNGO RT050N

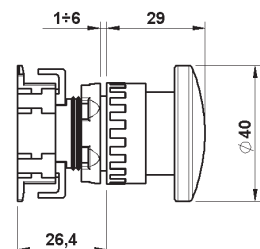



Fungo assiale con sblocco. Corpo in tecnopolimero, elemento frontale rotondo.
Axial mushroom with turn reset. Technopolymer body, round front element.



COLOR	CODE	REF.	DIAM.
rosso-red	1003A00052	FUNGO RT 06SR-40	40 mm
rosso-red	1003A00057	FUNGO RT 06SR-60	60 mm

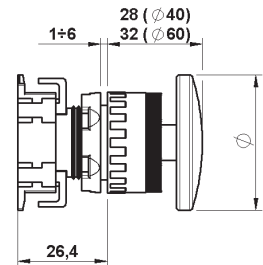

Leva oscillante. Corpo in tecnopolimero, elemento frontale rotondo.
Multi-directional lever. Technopolymer body, round front element.



COLOR	CODE	REF.
rosso-red	1003A00046	LEVA RT054R

